

# 接线盒安装说明书 PV-JK002xy Series

## Junction Box Installation Instructions for PV-JK002xy Series

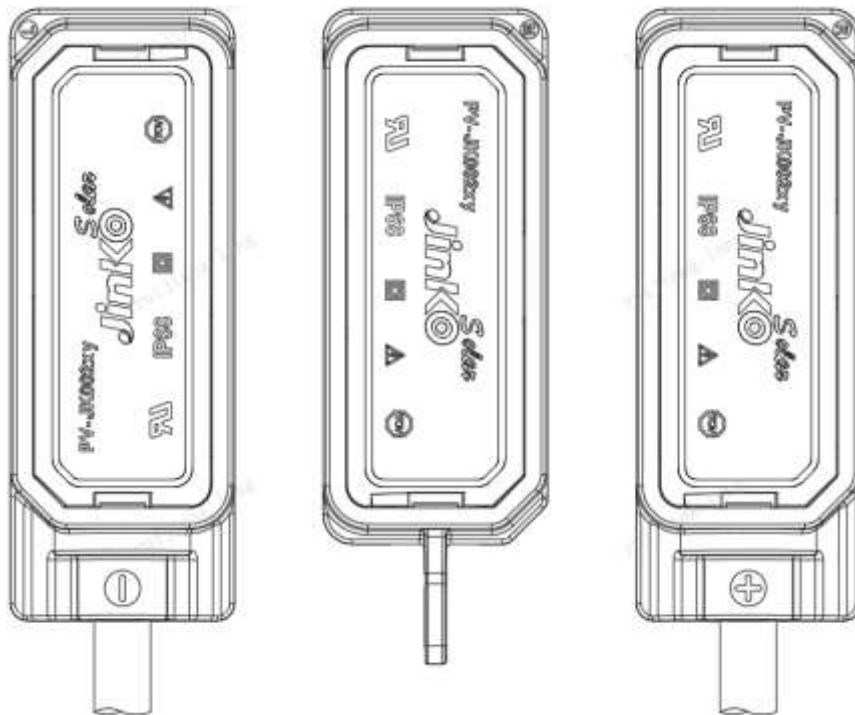

## 1. 注意事项 Matters Need Attention

- ◇ 确保遵守以下程序，以避免对人和产品的任何潜在伤害。  
Ensure that comply with the following procedure in order to avoid any potential damage to people and products.
- ◇ 请按照本说明操作，以免影响性能。  
Follow these instructions to avoid affecting performance.
- ◇ 请勿在负载情况下插拔。  
Do not disconnect under load.
- ◇ 太阳能组件在生产和储存过程中应错位放置，以有效地分散硅胶中的挥发性。否则会导致硅胶内部挥发性物质与连接器发生化学反应。  
The solar modules should be dislocation placed during production and storage in order to effectively spread volatile inside silicon glue. Otherwise, it will lead to a chemical reaction between the volatile substances inside the silicone and the connector.
- ◇ 在模块组装过程中，接线盒应远离任何腐蚀性物质。  
During module assembly, the junction box should be kept away from any corrosive substances.

## 2. 技术参数 Technical Data

系列名称 Model Name	Models PV-JK002 xyabcd series, where x=1 or 2, y=1, 2 or 3, a=1, b=1, 2, 3, 4, 5, 6, 7, 8, 9, 10, 11, 12 or 13, c=1, 2, 3 or 4, d=1.
额定电压 Rated Voltage (V DC)	1000VDC for PV-JK002xy(x=1) 1500VDC for PV-JK002xy(x= 2)
额定电流 Rated Current (A DC)	20A for PV-JK002xy (x=1 or 2, y=1) 25A for PV-JK002xy (x=1 or 2, y=2) 30A for PV-JK002xy (x=1 or 2, y=3)
工作温度 Operating Temperature	- 40℃ to +85℃
外壳材料 RTI(Elec and Str)参数 RTI(Elec and Str) Housing Material	110℃
过压等级 / 污染等级 Over Voltage Category / Pollution Degree	CAT III/ 1
应用等级 Application Class	Class A
适配的电缆规格 Suitable cable	4mm <sup>2</sup> /12 AWG
防火等级 Flammability Class	5VA
防护等级 Degree of Protection	IP68(1m, 2h)
金属材料 Contact material	铜 Copper
绝缘材料 Insulation Material	PPE/PPO
二极管 Diode Rating	30A, 45V for 30SQ045, for PV-JK002xy (c=1) 40A, 50V for 40SQ050A, for PV-JK002xy (c=2) 40A, 50V for 40SQ050B, for PV-JK002xy (c=3) 35A, 50V for 35SQ050, for PV-JK002xy (c=4)
认证标准 Certification Standard	TÜV IEC62790; UL3730

### 3. 汇流条大小和所需工具 Bus Bar Dimensions and Required Tools

安装示意图 Installation diagram

所需工具 Required tools:

电烙铁，用于焊带和端子之间的焊接

Electric iron for the solder between ribbons and terminal

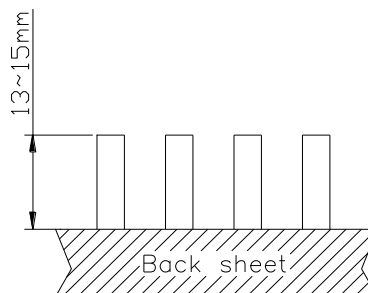
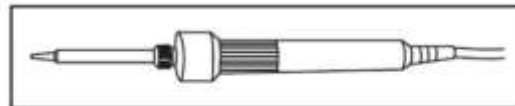
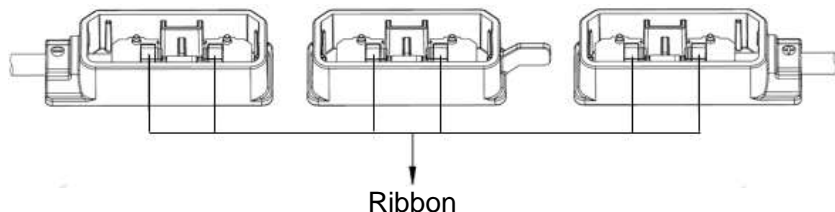

### 4. 安装 Installation 4.1 密封胶 Sealing Glue

◇ 将密封胶均匀地涂在接线盒背面，沿着密封槽。如下图所示：

Apply the sealant evenly on the back of the junction box, along the seal groove, as shown below.

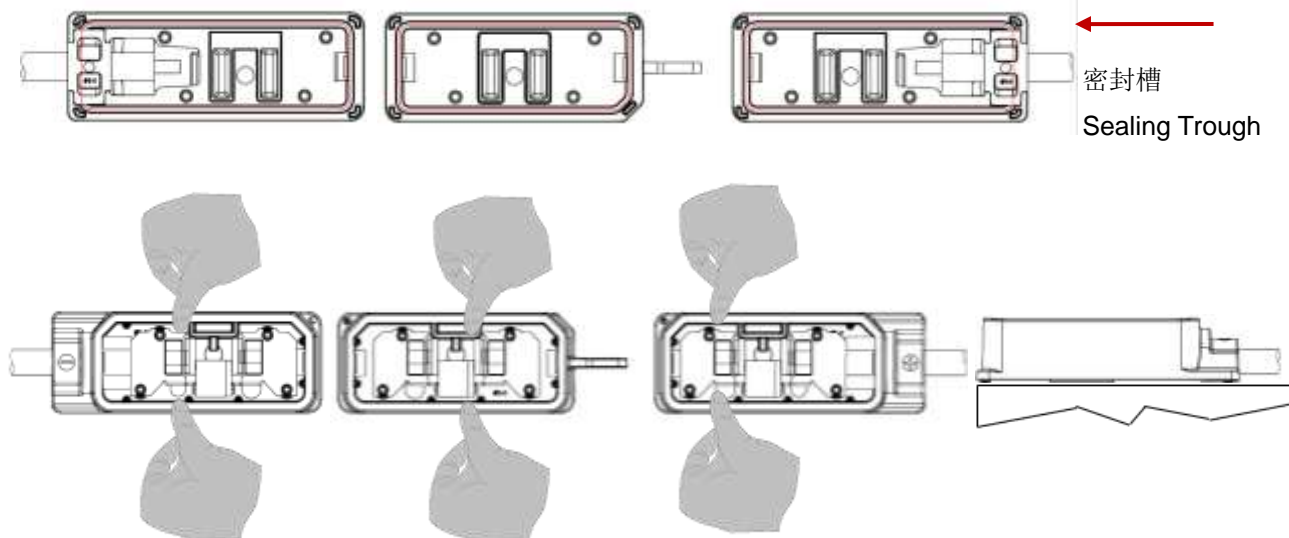

Note: 1. 安装表面应干燥、透明、坚硬，无发霉剂残留。特别是，请确保不会出现凝露现象。例如，将零件从寒冷的环境中带到温暖的环境中会导致冷凝。

The surface for installation should be dry, clear, hard, and without the residue of mold agent.

Especially, please ensure that there will be no condensation. For example, bringing the parts from cold environment to warm circumstance will cause condensation.

2. 接线盒四周溢出硅胶的宽度至少为 2 mm。请按照本说明操作，以免影响性能。

The width of silicone spilled around the junction box shall be at least 2 mm. Follow these instructions to avoid affecting performance.

### 4.2 焊带 Welding Ribbons

✧ 将焊带剪成所需长度，插入接线盒导孔，然后弯曲。只需用镊子之类的工具将汇流条与接线盒引线之间进行定位。用电烙铁和锡焊丝将焊带和铜接线端子牢固地焊接起来。

Cut the ribbon to the length needed, insert it to the guide hole of junction box, and then curve. Only need tools like tweezers to positioned between the ribbon of backsheet and the terminal of junction box. Weld the ribbon and cooper terminal firmly with electric iron and tin wire.

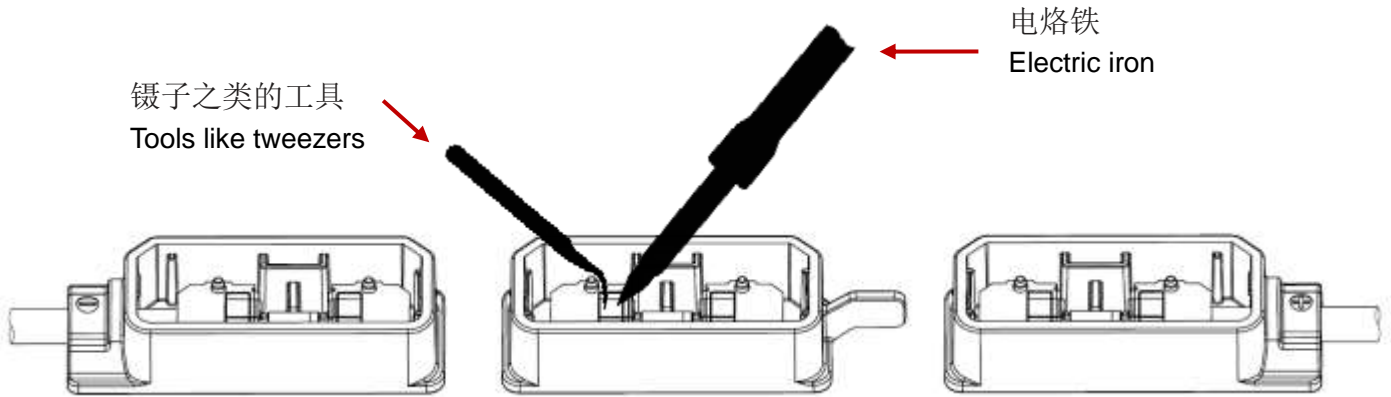

**供参考 For reference:**

- 1. 电烙铁功率 150W    Electric soldering iron power 150W;
- 2. 焊接时间: <5 s    Weld time: no more than 5 seconds;
- 3. 电烙铁焊接温度:300℃~380℃    Electric soldering iron soldering temperature:300℃~380℃。

注:焊带的焊接位置为出厂前预焊。客户可根据实际需要增加锡量。

Note: Ribbon's soldering position just pre-tin before leaving factory. Customers could add the amount of tin according to products practical required.

### 4.3 灌封说明 Potting Instruction

✧ 接线盒灌封胶应与红色表面齐平。

Junction box potting sealant should be flush with the red surface.

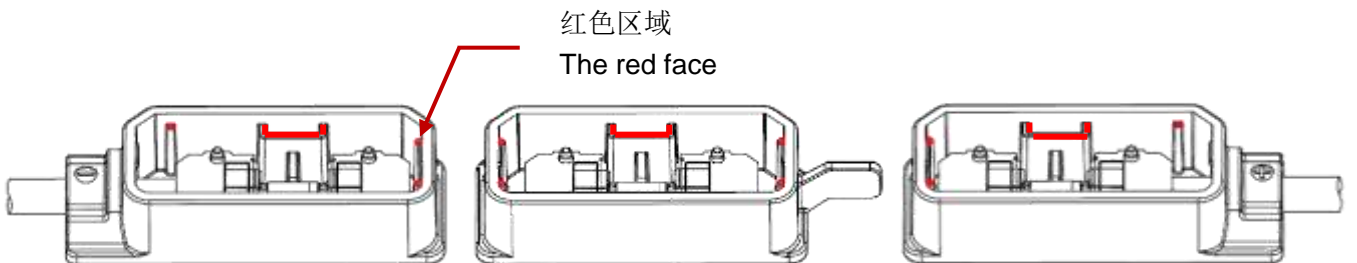

### 4.4 上盖 Cover

✧ 将上盖以一定角度插入底座，然后用‘A’和‘B’方向力将上盖推向底座。

Insert the cover into the base at a certain angle, and then push the cover towards the base with the force in the directions of 'A' and 'B'.

✧ 把上盖完全压到底部。

Press the cover completely to the bottom.

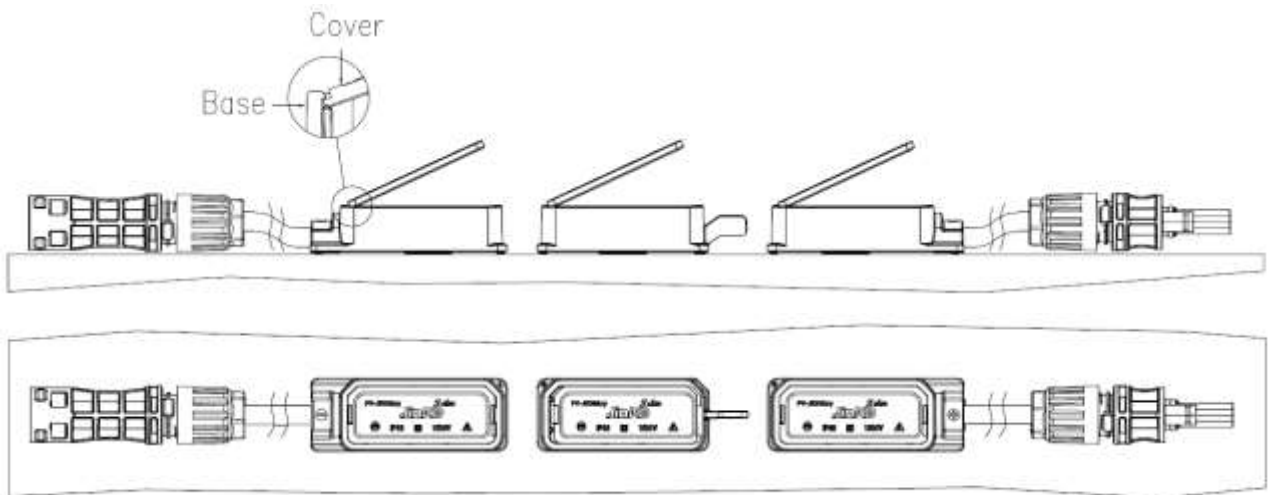

#### 4.5 安装提示 Installation Warning

✧ 在自行安装时，如果所用的部件不是 Jinko 官方指定的，或者没有按照官方要求进行准备和安装操作，我们将不保证产品的安全性和技术参数的一致性。

During self-installation, if the components used are not officially designated by Jinko, or are not prepared and installed according to official requirements, we will not guarantee the safety of the product and the consistency of technical parameters.

在安装过程中，应避免接触机械油、油脂、溶剂等可能会造成接线盒功能失效的物质，同时需注意施工人员的手套不能带有以上物质。被污染的接线盒不能使用。

During the installation process, avoid contact with materials that may cause the terminal box to fail, such as mechanical oil, grease, solvents, etc. At the same time, please pay attention that the gloves of the construction personnel must not carry the above substances. Contaminated junction box cannot be used.

✧ 该说明书中的所有操作不允许在带电或者负载下进行。

Operations in this manual must not be carried out under power or load.

#### 5. 注意 Note

✧ 接线盒用密封胶安装到光伏组件后，每个组件应保持在 2cm 以上的间距；我们需要等 12 个小时才能让密封胶凝固，之后才能装入灌封胶，因为接线盒的硅胶和灌封胶的安装可能会释放一些有害的腐蚀性空气，对塑料和人类有害。

After the junction box sealed to the PV Module with a sealant, each module kept away above 2cm. We need to wait 12 hours for the sealant to solidify before loading the potting compound. Because the installation may release some harmful corrosive air, which is harmful to plastic and humans.

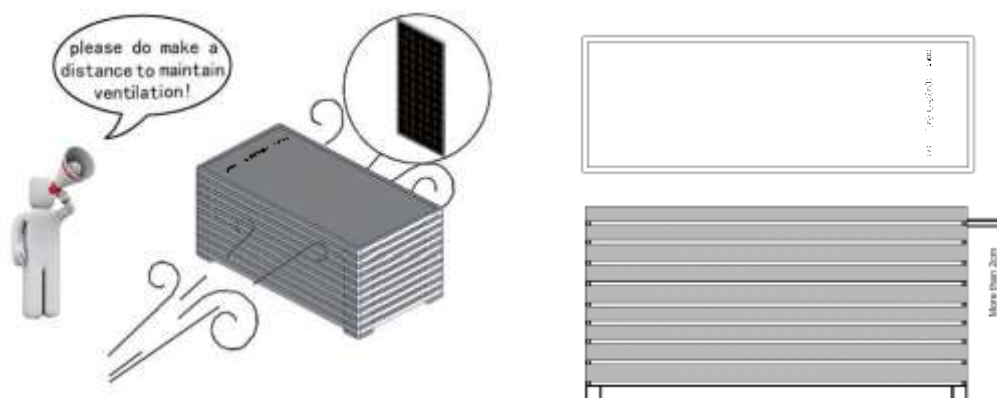

## 6. 电缆连接 Cable Connection

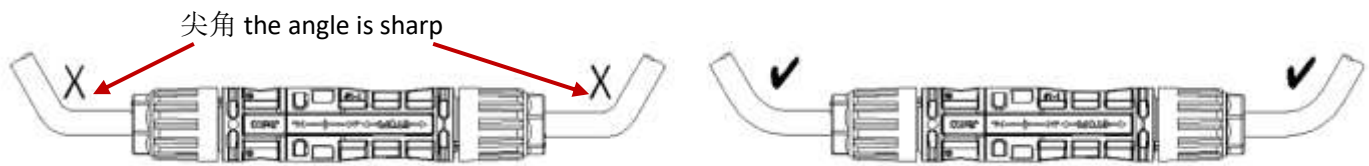

注:请参考厂家提供的最小弯曲半径的详细说明

Note: Please refer to the detailed instruction of the min. bend radius given by manufacturer.

### 连接状态 The state after connection



## 7. 声明 Statement

- ✧ 未经晶科书面许可，不得以任何形式复制、转让、分发或存储本文件内容。  
It is forbidden to copy, transfer, distribute or store in any shape of form of the content in this document without any written permission from Jinko.
- ✧ 任何技术改进或外观改变均应以产品和铭牌为准。所有的修改将包括在这个文件的新版本，我们不会另行通知。  
Any technical improvement or outward change will be subjected to the product and nameplate. All the alterations will be included in the new edition of this file and we will not inform additionally.
- ✧ 电气安装说明应包含根据国家电气规范ANSI/NFPA 70所使用的布线方法的详细描述。  
The electrical installation instructions shall include a detailed description of the wiring method to be used in accordance with the National Electrical Code, ANSI/NFPA 70.

备注：接线盒安装过程中操作困难或无法操作，请参照如下联络方式询问、查询：

Notes: If you have any questions during the installation, please feel free to contact us as follows:

**江西晶科光伏材料有限公司**  
Jiangxi Jinko PV Material Co., Ltd.

地址：江西省上饶市经济技术开发区兴业大道 10 号

Add: No.10, Xingye Road, Economic Development Zone, Shangrao, Jiangxi Province, P.R. China

电话 Tel.: (+86) 0793-8876086

邮编 Postcode: 334100

网址 Website: [www.jinkopvm.com](http://www.jinkopvm.com)

**销售联系方式**  
Sales Contact Information

电话 Tel.: (+86) 0793-8876028

邮箱 E-mail: [sale.pvm@jinkosolar.com](mailto:sale.pvm@jinkosolar.com)

**技术联系方式**  
Technician Contact Information

电话 Tel.: (+86) 0793-8876018

邮箱 E-mail: [rd.pvm@jinkosolar.com](mailto:rd.pvm@jinkosolar.com)

